

# Panasonic®

## CD Stereo System Operating Instructions

Model No. **SC-AK630**



For U.S.A.



As an ENERGY STAR® Partner, Panasonic has determined that this product meets the ENERGY STAR® guidelines for energy efficiency.



Before connecting, operating or adjusting this product, please read the instructions completely.  
Please keep this manual for future reference.

The model number and serial number of this product can be found on either the back or the bottom of the unit. Please note them in the space provided below and keep for future reference.

MODEL NUMBER \_\_\_\_\_  
SERIAL NUMBER \_\_\_\_\_

### User memo:

DATE OF PURCHASE \_\_\_\_\_  
DEALER NAME \_\_\_\_\_  
DEALER ADDRESS \_\_\_\_\_  
\_\_\_\_\_  
TELEPHONE NUMBER \_\_\_\_\_

## Table of contents

Listening caution .....	2
<b>IMPORTANT SAFETY INSTRUCTIONS</b> .....	3
Supplied accessories .....	3
The remote control .....	3
Set-up .....	4
Turning the demo function on/off .....	4
Front panel controls .....	5
Disc information .....	6
<b>Discs</b> .....	6
Basic play .....	6
Album skip play .....	7
CD display .....	7
To listen to specific discs and tracks (Play Mode function) .....	7
Program play .....	8
Repeat play .....	8
Marking a track .....	8
INTRO function (Album scan) .....	9
Title search function .....	9
<b>Radio</b> .....	10
<b>Cassettes</b> .....	11
<b>Setting the time</b> .....	11
<b>Timers</b> .....	12
<b>Sound quality/sound field</b> .....	13
<b>Other functions</b> .....	13
External unit connections .....	13
Using an external unit .....	13
Using headphones (not included) .....	13
Auto-off function .....	13
Convenient functions .....	13
<b>Troubleshooting guide</b> .....	14
<b>Specifications</b> .....	15
<b>Maintenance</b> .....	15
<b>Product Service</b> .....	15
<b>Limited Warranty (ONLY FOR U.S.A.)</b> .....	Back cover

## Dear customer

Thank you for purchasing this product. For optimum performance and safety, please read these instructions carefully.

These operating instructions are applicable to the following system.

<b>System</b>	SC-AK630
<b>Main unit</b>	SA-AK630
<b>Front speakers</b>	SB-AK630
<b>Subwoofer</b>	SB-WAK630

### CAUTION!

**THIS PRODUCT UTILIZES A LASER. USE OF CONTROLS OR ADJUSTMENTS OR PERFORMANCE OF PROCEDURES OTHER THAN THOSE SPECIFIED HEREIN MAY RESULT IN HAZARDOUS RADIATION EXPOSURE. DO NOT OPEN COVERS AND DO NOT REPAIR YOURSELF. REFER SERVICING TO QUALIFIED PERSONNEL.**

### WARNING:

**TO REDUCE THE RISK OF FIRE, ELECTRIC SHOCK OR PRODUCT DAMAGE, DO NOT EXPOSE THIS APPARATUS TO RAIN, MOISTURE, DRIPPING OR SPLASHING AND THAT NO OBJECTS FILLED WITH LIQUIDS, SUCH AS VASES, SHALL BE PLACED ON THE APPARATUS.**

### CAUTION!

**DO NOT INSTALL OR PLACE THIS UNIT IN A BOOKCASE, BUILT-IN CABINET OR IN ANOTHER CONFINED SPACE. ENSURE THE UNIT IS WELL VENTILATED. TO PREVENT RISK OF ELECTRIC SHOCK OR FIRE HAZARD DUE TO OVERHEATING, ENSURE THAT CURTAINS AND ANY OTHER MATERIALS DO NOT OBSTRUCT THE VENTILATION VENTS.**

The socket outlet shall be installed near the equipment and easily accessible or the mains plug or an appliance coupler shall remain readily operable.



**CAUTION**  
**RISK OF ELECTRIC SHOCK**  
**DO NOT OPEN**



**CAUTION:** TO REDUCE THE RISK OF ELECTRIC SHOCK, DO NOT REMOVE SCREWS. NO USER-SERVICEABLE PARTS INSIDE. REFER SERVICING TO QUALIFIED SERVICE PERSONNEL.



The lightning flash with arrowhead symbol, within an equilateral triangle, is intended to alert the user to the presence of uninsulated "dangerous voltage" within the product's enclosure that may be of sufficient magnitude to constitute a risk of electric shock to persons.



The exclamation point within an equilateral triangle is intended to alert the user to the presence of important operating and maintenance (servicing) instructions in the literature accompanying the appliance.

## Listening caution



Selecting fine audio equipment such as the unit you've just purchased is only the start of your musical enjoyment. Now it's time to consider how you can maximize the fun and excitement your equipment offers. This manufacturer and the Electronic Industries Association's Consumer Electronics Group want you to get the most out of your equipment by playing it at a safe level. One that lets the sound come through loud and clear without annoying blaring or distortion—and, most importantly, without affecting your sensitive hearing.

We recommend that you avoid prolonged exposure to excessive noise.

Sound can be deceiving. Over time your hearing "comfort level" adapts to higher volumes of sound. So what sounds "normal" can actually be loud and harmful to your hearing.

Guard against this by setting your equipment at a safe level BEFORE your hearing adapts.

To establish a safe level:

- Start your volume control at a low setting.
- Slowly increase the sound until you can hear it comfortably and clearly, and without distortion.

Once you have established a comfortable sound level:

- Set the dial and leave it there.

Taking a minute to do this now will help to prevent hearing damage or loss in the future. After all, we want you listening for a lifetime.

### THE FOLLOWING APPLIES ONLY IN THE U.S.A.:

#### CAUTION:

This equipment has been tested and found to comply with the limits for a Class B digital device, pursuant to Part 15 of the FCC Rules.

These limits are designed to provide reasonable protection against harmful interference in a residential installation. This equipment generates, uses and can radiate radio frequency energy and, if not installed and used in accordance with the instructions, may cause harmful interference to radio communications. However, there is no guarantee that interference will not occur in a particular installation. If this equipment does cause harmful interference to radio or television reception, which can be determined by turning the equipment off and on, the user is encouraged to try to correct the interference by one or more of the following measures:

- Reorient or relocate the receiving antenna.
- Increase the separation between the equipment and receiver.
- Connect the equipment into an outlet on a circuit different from that to which the receiver is connected.
- Consult the dealer or an experienced radio/TV technician for help.

Any unauthorized changes or modifications to this equipment would void the user's authority to operate this device.

This device complies with Part 15 of the FCC Rules. Operation is subject to the following two conditions: (1) This device may not cause harmful interference, and (2) this device must accept any interference received, including interference that may cause undesired operation.

### Except for U.S.A.

<b>CAUTION</b>	- INVISIBLE LASER RADIATION WHEN OPEN. AVOID EXPOSURE TO BEAM. IEC60825-1 / Class 3b
<b>WARNING</b>	- OSYNLIG LASERSTRÅLNING NÄR DENNA DEL ÄR ÖPPNAD. BETRÄKTA EJ STRÅLEN.
<b>ADVARSEL</b>	- USYNLIG LASERSTRÅLING VED ÅBNING. UNDGÅ UDSETTELSE FOR STRÅLING.
<b>ADVARSEL</b>	- USYNLIG LASERSTRÅLING NÄR DENSEL ÄPPNES. UNNGÅ EXPOSERING FOR STRÅLEN.
<b>VARO!</b>	- AVATTAESSA OLET NÄKYMÄTÖNTÄ ALTTIINA LASERSÄTEILYLLE. ÄLÄ KATSO SÄTEESEEN.
<b>VORSICHT</b>	- UNSICHTBARE LASERSTRÄHLUNG, WENN ABDECKUNG GEÖFFNET. NICHT DEM STRAHL AUSSETZEN.
<b>ATTENTION</b>	- RAYONNEMENT LASER INVISIBLE EN CAS D'OUVERTURE. EXPOSITION DANGEREUSE AU FAISCEAU.
注意	- 打开时有不可见激光照射。避免激光束照射。
注意	- ここを開くと不可見レーザー光が出ます。ビームを見たり、触れたりしないで下さい。 RQLX50058

Inside of product

# IMPORTANT SAFETY INSTRUCTIONS

Read these operating instructions carefully before using the unit. Follow the safety instructions on the unit and the applicable safety instructions listed below. Keep these operating instructions handy for future reference.

- 1) Read these instructions.
- 2) Keep these instructions.
- 3) Heed all warnings.
- 4) Follow all instructions.
- 5) Do not use this apparatus near water.
- 6) Clean only with dry cloth.
- 7) Do not block any ventilation openings. Install in accordance with the manufacturer's instructions.
- 8) Do not install near any heat sources such as radiators, heat registers, stoves, or other apparatus (including amplifiers) that produce heat.
- 9) Do not defeat the safety purpose of the polarized or grounding-type plug. A polarized plug has two blades with one wider than the other. A grounding-type plug has two blades and a third grounding prong. The wide blade or the third prong are provided for your safety. If the provided plug does not fit into your outlet, consult an electrician for replacement of the obsolete outlet.
- 10) Protect the power cord from being walked on or pinched particularly at plugs, convenience receptacles, and the point where they exit from the apparatus.
- 11) Only use attachments/accessories specified by the manufacturer.
- 12) Use only with the cart, stand, tripod, bracket, or table specified by the manufacturer, or sold with the apparatus. When a cart is used, use caution when moving the cart/apparatus combination to avoid injury from tip-over. 
- 13) Unplug this apparatus during lightning storms or when unused for long periods of time.
- 14) Refer all servicing to qualified service personnel. Servicing is required when the apparatus has been damaged in any way, such as power-supply cord or plug is damaged, liquid has been spilled or objects have fallen into the apparatus, the apparatus has been exposed to rain or moisture, does not operate normally, or has been dropped.

## Supplied accessories

Please check and identify the supplied accessories. Use numbers indicated in parentheses when asking for replacement parts. (As of November 2004)  
**(Only for U.S.A.)**  
**To order accessories, refer to "Accessory Purchases" on the back cover.**

- AC power supply cord .. 1 pc. (K2CB2CB00018)       FM indoor antenna .. 1 pc. (RSA0006-L)

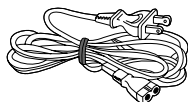

- Remote control transmitter ..... 1 pc. (N2QAHB000056)

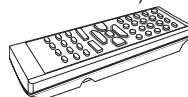

- AM loop antenna .. 1 pc. (N1DAAAA00001)

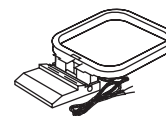

- Batteries for remote control ..... 2 pcs.

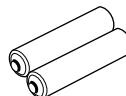

## The remote control

### Batteries

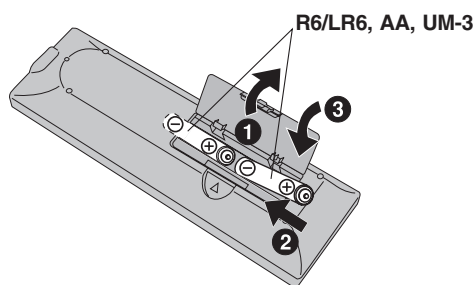

- Insert so the poles (+ and -) match those in the remote control.
- Do not use rechargeable type batteries.

#### Do not:

- mix old and new batteries.
  - use different types at the same time.
  - heat or expose to flame.
  - take apart or short-circuit.
  - attempt to recharge alkaline or manganese batteries.
  - use batteries if the covering has been peeled off.
  - keep together with metallic objects such as necklaces.
- Mishandling of batteries can cause electrolyte leakage which can damage items the fluid contacts and may cause a fire. If electrolyte leaks from the batteries, consult your dealer. Wash thoroughly with water if electrolyte comes in contact with any part of your body.

Remove if the remote control is not going to be used for a long period of time. Store in a cool, dark place. Replace if the unit does not respond to the remote control even when held close to the front panel.

### Use

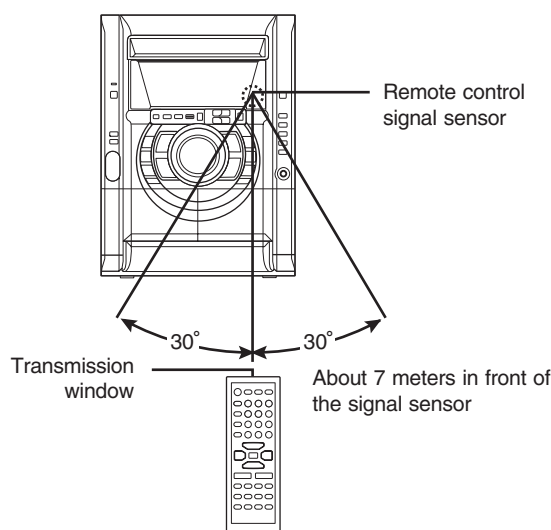

Aim at the sensor, avoiding obstacles, at a maximum range of 7 meters directly in front of the unit.

- Keep the transmission window and the unit's sensor free from dust.
- Operation can be affected by strong light sources, such as direct sunlight, and the glass doors on cabinets.

#### Do not:

- put heavy objects on the remote control.
- take the remote control apart.
- spill liquids onto the remote control.

# Set-up

Connect the AC power supply cord only after all other connections have been made.  
Optional antenna connections (➔ page 10).

## Preparation

Twist and pull off the vinyl tip of the antenna wires and speaker cords.

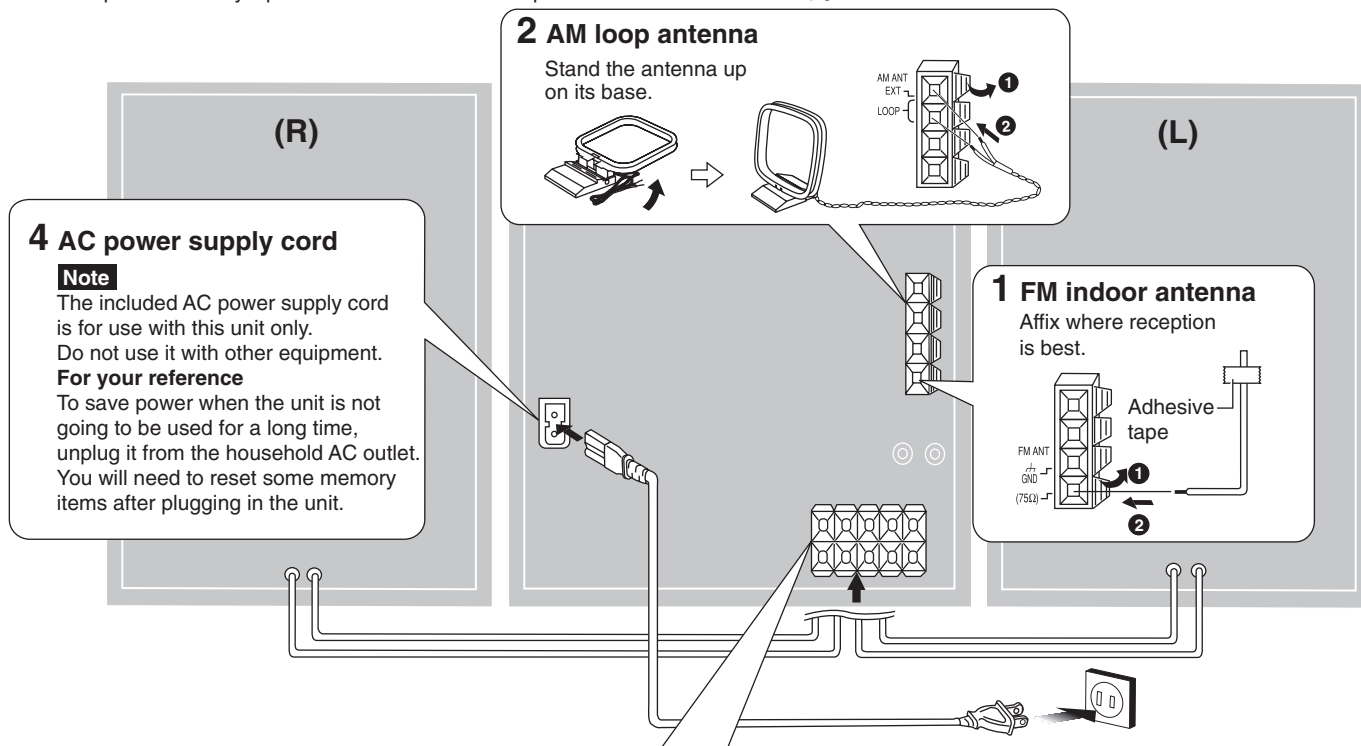

## 3 Speakers

### Placement

Place the front speakers so that the super tweeter is on the inside.

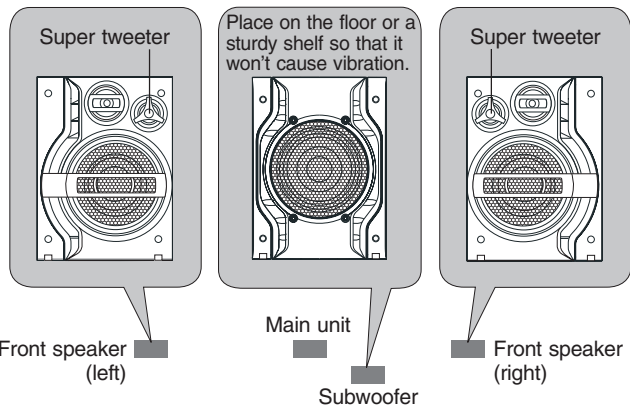

### Note

- Keep your speakers at least 10 mm (13/32") away from the system for proper ventilation.
- These speakers do not have magnetic shielding. Do not place them near televisions, personal computers or other devices easily influenced by magnetism.
- You cannot take the front net off the speakers.

### Connection

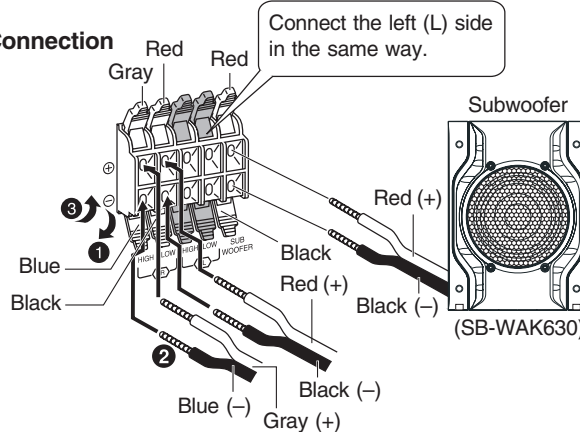

### Use only the supplied speakers.

The combination of the main unit and speakers provide the best sound. Using other speakers can damage the unit and sound quality will be negatively affected.

### Notes on speaker use

- You can damage your speakers and shorten their useful life if you play sound at high levels over extended periods.
- Reduce the volume in the following cases to avoid damage.
  - When playing distorted sound.
  - When adjusting the sound quality.



### Caution

- Use the speakers only with the recommended system. Failure to do so may lead to damage to the amplifier and/or the speakers, and may result in the risk of fire. Consult a qualified service person if damage has occurred or if you experience a sudden change in performance.
- Do not attach these speakers to walls or ceilings.

## Turning the demo function on/off

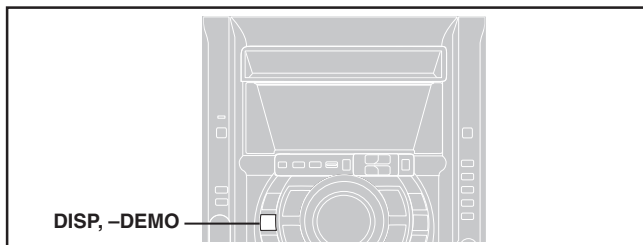

When the unit is first plugged in, a demonstration of its functions may be shown on the display.  
If the demo setting is off, you can show a demonstration by selecting "DEMO ON".

### Press and hold [DISP, -DEMO].

The display changes each time the button is held down.  
NO DEMO (off) ↔ DEMO ON (on)

While in the standby mode, select "NO DEMO" to reduce power consumption.

### Note

DEMO function cannot be turned on when Dimmer is on.

# Front panel controls

## Main unit

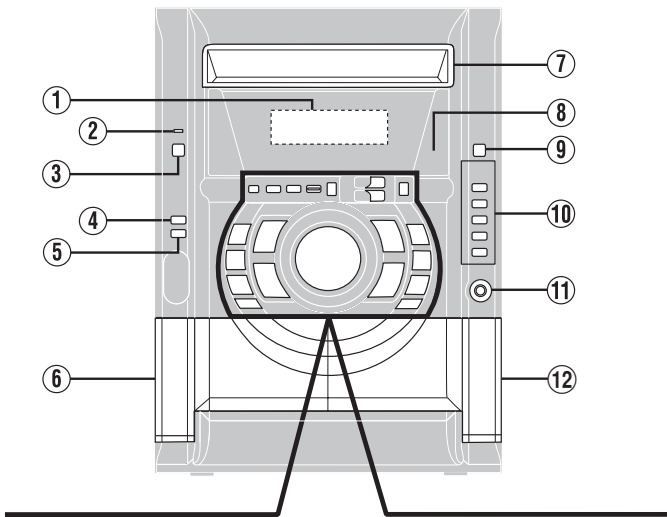

- ① Display
- ② AC supply indicator [AC IN]  
This indicator lights when the unit is connected to the AC power supply.
- ③ Standby/on switch [⏻/I, POWER]  
Press to switch the unit from on to standby mode or vice versa. In standby mode, the unit is still consuming a small amount of power.
- ④ H.BASS button [H.BASS] ..... 13
- ⑤ Subwoofer button [SUBWOOFER] ..... 13
- ⑥ Deck 1 cassette holder ..... 11
- ⑦ Disc tray
- ⑧ Remote control signal sensor ..... 3
- ⑨ CD tray open/close button [⏏, OPEN/CLOSE] ..... 6
- ⑩ CD direct play buttons [1 - 5] ..... 6
- ⑪ Headphone jack [PHONES] ..... 13
- ⑫ Deck 2 cassette holder ..... 11

## Center console

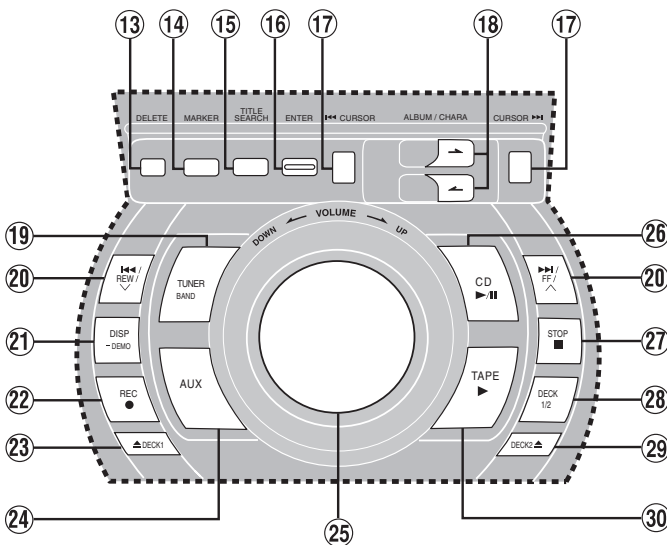

- ⑬ Delete button [DELETE] ..... 8, 9
- ⑭ Marker memory/recall button [MARKER] ..... 8
- ⑮ Title search mode select button [TITLE SEARCH] ..... 9
- ⑯ Enter button [ENTER] ..... 8, 9
- ⑰ Cursor buttons [◀ CURSOR, CURSOR ▶] ..... 9
- ⑱ Album skip, character buttons [▶, ALBUM/CHARA, ◀, ALBUM/CHARA] ..... 7, 9
- ⑲ Tuner/band select button [TUNER, BAND] ..... 10
- ⑳ CD skip/search, tape fast-forward/rewind, tune/preset channel select, time adjust buttons [◀◀/REW/V, ▶▶/FF/∧] ..... 6, 9-11
- ㉑ Display, demonstration button [DISP, -DEMO] ..... 4, 13
- ㉒ Record button [●, REC] ..... 11
- ㉓ Deck 1 open button [⏏ DECK1] ..... 11
- ㉔ AUX button [AUX] ..... 13
- ㉕ Volume control [VOLUME DOWN, UP] ..... 13
- ㉖ CD play/pause button [▶/II, CD] ..... 6
- ㉗ Stop/program clear button [■, STOP] ..... 6, 8, 9, 11
- ㉘ Deck select button [DECK 1/2] ..... 11
- ㉙ Deck 2 open button [DECK2 ⏏] ..... 11
- ㉚ Tape play button [▶, TAPE] ..... 11

## Remote control

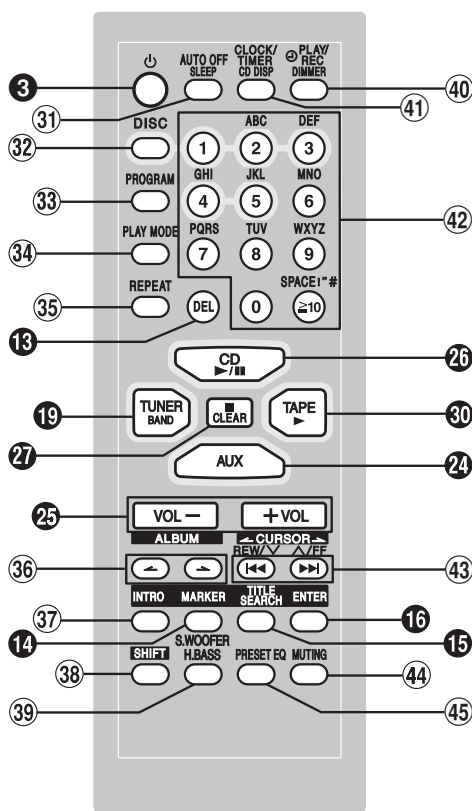

Buttons such as ③ function in exactly the same way as the buttons on the main unit.

- ③① Sleep timer + Auto off button [SLEEP, AUTO OFF] ..... 12, 13
- ③② Disc button [DISC] ..... 7
- ③③ Program button [PROGRAM] ..... 8, 10
- ③④ Play mode select button [PLAY MODE] ..... 7, 10, 11  
Use this for selecting CD play mode, tune mode, FM mode and deck select.
- ③⑤ Repeat button [REPEAT] ..... 8
- ③⑥ Album skip buttons [◀, ▶, ALBUM] ..... 7
- ③⑦ Intro button [INTRO] ..... 9
- ③⑧ Shift button [SHIFT]  
To use functions labeled in orange \*:  
While pressing [SHIFT], press the corresponding button.  
\* For buttons [AUTO OFF], [CLOCK/TIMER], [⊙PLAY/REC] and [S.WOOFER]
- ③⑨ H.BASS + Subwoofer button [H.BASS, S.WOOFER] ..... 13
- ④① Dimmer + Play timer/record timer button [DIMMER, ⊙PLAY/REC] ..... 12, 13
- ④② CD display + Clock/timer button [CD DISP, CLOCK/TIMER] ..... 7, 11
- ④③ Numbered, character buttons [▶10, 1-9, 0, A-Z, SPACE! "#] ..... 7-10
- ④④ CD skip/search, tape fast-forward/rewind, tune/preset channel select, time adjust, cursor buttons [◀◀, REW/V, ▶, CURSOR, ▶▶, ∧/FF, CURSOR ▶] ..... 8-11
- ④⑤ Muting button [MUTING] ..... 13
- ④⑥ Preset EQ select button [PRESET EQ] ..... 13

# Disc information

## Disc selection

This unit can play MP3 and CD-DA (digital audio) format audio CD-R and CD-RW that have been finalized (a process that enables CD-R/CD-RW players to play audio CD-R and CD-RW) upon completion of recording. It may not be able to play some CD-R or CD-RW due to the condition of the recording.

Disc type	Logo	Indication used in instructions
Audio CD		CD
CD-R/RW	—	CD MP3 (Depending on the recording format → see above)

### Do not:

- use irregularly shaped discs.
- attach extra labels and stickers.
- use discs with labels and stickers that are coming off or with adhesive exuding from under labels and stickers.
- attach scratch proof covers or any other kind of accessory.
- write anything on the disc.
- clean discs with liquids. (Wipe with a soft, dry cloth.)
- use discs printed with label printers available on the market.



## To prevent damage

Always observe the following points:

- Load only 1 disc on the tray.
- Always stop the changer before loading or changing discs. Do not change discs while a disc is playing.
- Set the system on a flat, level surface.
- Always unload all discs before moving the unit.

### Do not:

- set the unit on top of magazines, inclined surfaces, etc.
- move the unit while a tray is opening/closing, or when loaded.
- put anything except a disc in the tray.
- use cleaning discs or discs which are badly warped or cracked.
- disconnect the AC power supply cord from the household AC outlet during disc changing operation.

## MP3 information

This unit can play MP3 files recorded on CD-R/RW with a computer. Files are treated as tracks and folders are treated as albums. This unit can access up to 999 tracks, 255 albums and 20 sessions.

### When making MP3 files to play on this unit

#### Disc format

Discs must conform to ISO9660 level 1 or 2 (except for extended formats).

#### File format

MP3 files must have the extension “.MP3” or “.mp3”.

#### To play in a certain order

Prefix the folder and file names with 3-digit numbers in the order you want to play them. Files may not be recorded in numbered order if the prefixes have different numbers of digits. For example: 1track.mp3, 2track.mp3, 10track.mp3. However, some writing software may also cause recording to occur in a different order.

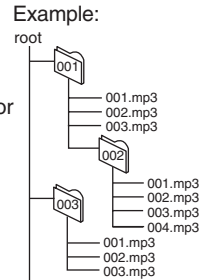

MPEG Layer-3 audio decoding technology licensed from Fraunhofer IIS and Thomson multimedia.

## Limitations on MP3 play

- This unit is not compatible with packet-write format.
- When both MP3 and CD-DA data is recorded on the disc over a number of sessions:
  - If the first session contains MP3 recordings, the unit will play from the MP3 made in that session till the session before the first CD-DA recordings.
  - If the first session contains CD-DA recordings, the unit will play only the recordings made in that session. The subsequent sessions will be ignored.
- Some MP3 may not be played due to the condition of the disc or recording.
- Recordings will not necessarily be played in the order you recorded them.

# Discs

## Basic play

CD MP3

### Pause

Press **[▶/II, CD]** during play. Press again to resume play.

**[▶/II, CD]**

**1 Press **[▲, OPEN/CLOSE]** to open the tray.**

The unit comes on. Load discs with label facing up. To load discs in other trays, press [1]–[5] to select the tray, then press **[▲, OPEN/CLOSE]**.



Current disc indicator

**2 Press **[▲, OPEN/CLOSE]** to close the tray.**

**3 Press [1]–[5] to play the disc.** You can also press **[▶/II, CD]** if the current disc is your desired disc.

**[1]–[5]**

Stop

### Skip/Search

Press **[◀/REW/V]** or **[▶/FF/∧]** to skip.

**MP3** Display when skipping in stop mode (example):

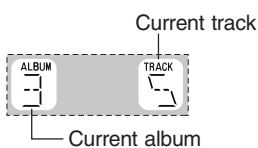

- During random play (→ page 7), you cannot skip to tracks already played.

**[CD]** Hold down during play or pause to search.

- During program play (→ page 8), or random play (→ page 7), you can search only within the track.



Press **[■, STOP]** during play.

**MP3** Display when in the stop mode (example):

“MP3”: Indicates the disc contains MP3 files

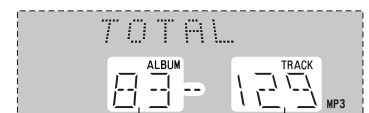

Total number of albums

Total number of tracks

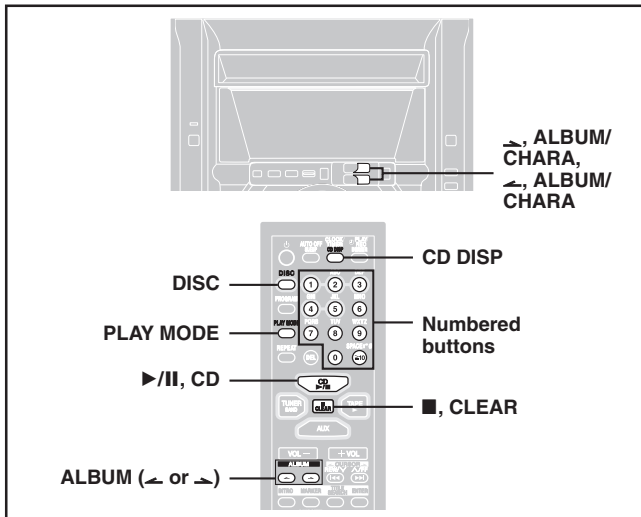

## Album skip play

MP3

During play or stop

Press [**<**, ALBUM/CHARA] or [**>**, ALBUM/CHARA] to select the desired album.

Remote control: Press [ALBUM (< or >)].

When selecting in the stop mode (example):

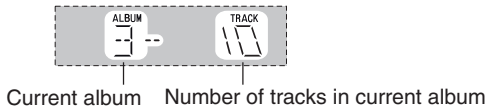

## CD display

CD MP3

Remote control only

You can select a desired CD display mode.

Press [CD DISP] during play or pause.

Every time you press the button:

[CD] Remaining play time ↔ Elapsed play time

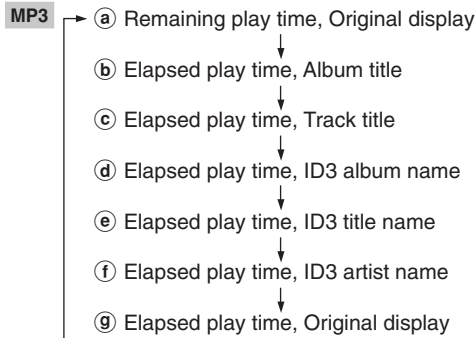

Example: ©

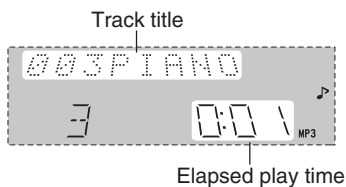

### Note

- When track number 25 or greater is playing, remaining play time display shows "--:--".

### MP3

- When a title is longer than 9 characters, it will scroll across the display. If you selected a mode from (b) - (f) (see above), the scrolling will start again after every 3 seconds.
- "NO ID3" is displayed if titles with ID3 tags haven't been entered.
- Maximum number of displayable characters:  
Album/track title: 31  
ID3 album/title/artist name: 30  
(ID3 is a tag embedded in MP3 track to provide information about the track.)
- This unit can display album and track titles with ID3 tags (version 1.0 and 1.1). Titles containing text data that the unit doesn't support cannot be displayed.
- Titles entered with 2-byte code cannot be displayed correctly on this unit.

## To listen to specific discs and tracks (Play Mode function)

CD MP3

- (a) ALL-DISC: Plays **all** loaded **discs** in succession from the selected disc to the final disc ※.
- (b) 1-SONG: Plays **one** selected **track** on the selected disc.
- (c) 1-ALBUM: **MP3** Plays **one** selected **album** on the selected disc.
- (d) 1-DISC  
RANDOM: Plays **one** selected **disc** in **random** order.
- (e) ALL-DISC  
RANDOM: **CD** Plays **all** loaded **discs** in **random** order.
- (f) 1-DISC: Plays **one** selected **disc**.
- (g) 1-ALBUM  
RANDOM: **MP3** Plays **one** selected **album** in **random** order.

### Remote control only

Preparation: Press [▶/II, CD] and then [■, CLEAR].

Press [PLAY MODE] to select the desired mode.

Every time you press the button:

[CD]

(a) ALL-DISC → (b) 1-SONG → (d) 1-DISC RANDOM  
↑ (f) 1-DISC ← (e) ALL-DISC RANDOM ←

[MP3]

(a) ALL-DISC → (b) 1-SONG → (c) 1-ALBUM → (d) 1-DISC RANDOM  
↑ (f) 1-DISC ← (g) 1-ALBUM RANDOM ←

### ALL-DISC RANDOM [CD]

Press [▶/II, CD] to start play.

### ALL-DISC/1-DISC/1-DISC RANDOM [CD] MP3

Press [DISC] and then [1]–[5] to select the disc.

Play starts.

### 1-ALBUM/1-ALBUM RANDOM [MP3]

1 Press [DISC] and then [1]–[5] to select the disc.

2 Press [ALBUM (< or >)] to select the album.

Play starts from the selected album.

### 1-SONG

[CD]

1 Press [DISC] and then [1]–[5] to select the disc.

2 Press the numbered buttons to select the track in the current disc.

To select a 2-digit track, press [≥10] once then the two digits.

Play starts from the selected track.

[MP3]

1 Press [DISC] and then [1]–[5] to select the disc.

2 Press [ALBUM (< or >)] to select the album.

3 Press the numbered buttons to select the track in the current album.

To select a 2-digit track, press [≥10] once then the two digits.

To select a 3-digit track, press [≥10] twice then the three digits.

Play starts from the selected track.

### To stop play

Press [■, CLEAR].

### When playback ends

The current play mode will be retained in memory until it is changed even if the unit is turned off.

### ※ Final disc

For example, if play starts from disc 4, disc 3 will be the "final disc".

Order of progression: Disc 4→5→1→2→3

### ■ MP3 When "NOT MP3/ERROR1" appears on the display

An unsupported MP3 format is being played. The unit will skip that track and play the next one.

### Note

- You cannot use program mode together with Play Mode function.
- [MP3] During 1-ALBUM mode, track skipping can only be done within the current album.

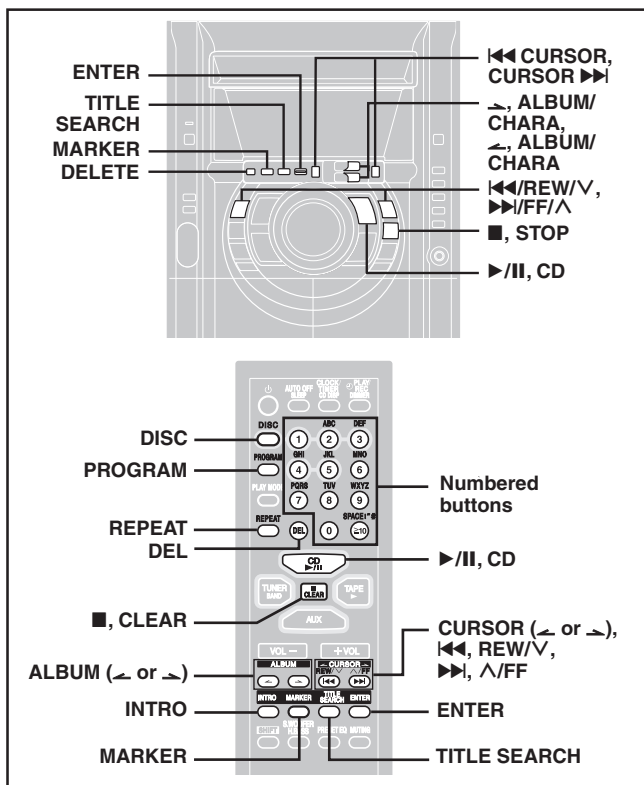

## Program play

CD MP3

You can program up to 24 tracks.

### Remote control only

CD

**Preparation:** Press ▶/II, CD] and then ■, CLEAR].

- 1 Press [PROGRAM].  
“PGM” appears.
- 2 Press [DISC] and then [1]–[5] to select the disc.
- 3 Select the tracks with the numbered buttons.  
To select a 2-digit track, press [≥10] once then the two digits.  
Repeat steps 2 and 3 to program other tracks.
- 4 Press ▶/II, CD] to start play.

MP3

**Preparation:**

1. Press [DISC] and then [1]–[5] to select the disc.
2. Press ■, CLEAR].
- 1 Press [PROGRAM].  
“PGM” appears.
- 2 Press [ALBUM (◀ or ▶)] to select the album.  
To select an album directly, press the numbered buttons after pressing [ALBUM (◀ or ▶)].  
To select a 2-digit album, press [≥10] once then the two digits.  
To select a 3-digit album, press [≥10] twice then the three digits.
- 3 Press [◀◀, REW/V] or [▶▶, △/FF] to select the track.  
To select a track directly, press the numbered buttons after pressing [◀◀, REW/V] or [▶▶, △/FF].  
To select a 2-digit track, press [≥10] once then the two digits.  
To select a 3-digit track, press [≥10] twice then the three digits.
- 4 Press [ENTER].  
Repeat steps 2 ~ 4 to program other tracks.
- 5 Press ▶/II, CD] to start play.

### To exit program mode

Press [PROGRAM] in the stop mode. (You can replay your program by pressing [PROGRAM] then ▶/II, CD].)

You can do the following while “P” is displayed



### To check program contents

Press [◀◀, REW/V] or [▶▶, △/FF].

Every time you press the button:

CD The track number and program order are displayed:

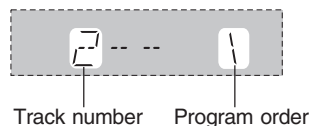

MP3 Program order is displayed, then album number and track number.

### To add to the program

CD Do steps 2 and 3.

MP3 Do steps 2 ~ 4.

### To clear the last track

Press [DEL].

### To clear all tracks

Press ■, CLEAR].

While “CLEAR ALL” is blinking, press the button again to clear all tracks.

### Note

- You cannot program CD-DA together with MP3 tracks.
- MP3 The program memory is cleared when you change a disc or open the disc tray.
- MP3 You cannot program more than one disc for MP3.

## Repeat play

CD MP3

### Remote control only

Press [REPEAT] during play.

“O” is displayed.

### To cancel repeat play

Press [REPEAT] to clear “O” .

### Note

You can use repeat mode with program play (→ see left) and Play Mode (→ page 7) functions.

## Marking a track

CD MP3

You can mark one track each on the discs loaded so that you can start play from them later.

### To mark a track

- 1 During play or stop  
Select your desired track.  
(→ page 6, “Basic play – Skip/Search”).
- 2 Hold down [MARKER] until “STORING” blinks on the display.  
The selected track is stored in the marker of the current disc.

### Note

If a track is already stored in the marker, it will be replaced next time you store a new track in the same marker.

### To recall a marked track number in the current disc

During play or stop

Press [MARKER] to recall a marker.

Play starts from the track recalled.

### Note

- “NO MARKER” indicates that the marker in the current disc is empty.
- The marker memory is cleared when you open the disc tray.
- You cannot use this function during program play or random play.



## INTRO function (Album scan)

MP3

You can find an album by listening to the first track of all albums in the current disc for 10 seconds each.

### Remote control only

**Preparation:** Press [▶/II, CD] and then [■, CLEAR].

#### 1 Press [INTRO].

INTRO function starts.

(INTRO function is cancelled after playing the first track in the last album on the current disc.)

#### 2 While your desired album is playing, press [▶/II, CD].

Play continues from the first track of the album.

To stop during the process, press [INTRO] or [■, CLEAR].

### Note

You cannot use this function during program play or random play.

## Title search function

MP3

You can search for your desired album/track with its keyword (part of the title).

### Album/track title search

**Preparation:** Press [▶/II, CD] and then [■, STOP].

- For album title search  
Press [TITLE SEARCH] once.  
For track title search  
Press [TITLE SEARCH] twice.

- Enter the characters of the keyword for the title.  
(→ see right: "Entering characters")

- Press [ENTER].  
Title search starts.

The matched title is displayed.

Album title search

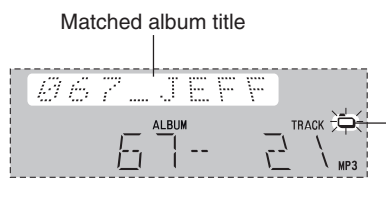

Blinks to indicate album title search mode

Track title search

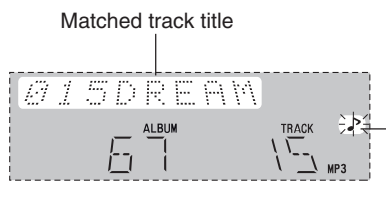

Blinks to indicate album title search mode

### To show the next/previous search result

Press [▶▶/FF/Λ] (next) or [◀◀/REW/V] (previous).

### Press [▶/II, CD] to start play from the album/track found.

For album search, play starts from the first track of the album.  
(Search mode is cancelled.)

### To cancel partway through

Press [■, STOP].

When there is no match for the searched keyword, the display shows "NOT FOUND".

### Note

You cannot use title search function in program play or random play.

### Entering characters

You can enter a keyword of up to 9 characters for album/track title search. You can only enter upper case letters but the unit also searches for lower case.

### On the main unit

- Press [↵, ALBUM/CHARA] or [↵, ALBUM/CHARA] to select the required character.

Each time you press [↵, ALBUM/CHARA], the characters change in the following order.

A	B	C	D	E	F	G	H	I	J	K	L	M	N	O	P	Q	R	S	T	U	V	W	X	Y	Z
1	2	3	4	5	6	7	8	9	0																
space ! " # \$ % & ' ( ) * + , - . / : ; < = > ? _ `																									

The sequence is reversed if you press [↵, ALBUM/CHARA].

If you hold down [↵, ALBUM/CHARA] or [↵, ALBUM/CHARA], the characters change faster.

- Press [CURSOR ▶▶] to enter the character.  
Repeat steps ①~② to complete the keyword.

### On the remote control

- Press the numbered button to select the required character.

Characters allocated to the numbered buttons:

Numbered buttons	Characters	Numbered buttons	Characters
1	1	6	M N O 6
2	A B C 2	7	P Q R S 7
3	D E F 3	8	T U V 8
4	G H I 4	9	W X Y Z 9
5	J K L 5	0	0
≥10	space ! " # \$ % & ' ( ) * + , - . / : ; < = > ? _ `		

The characters change each time a numbered button is pressed.  
For example, every time you press [2]:

A → B → C → 2

- Press [CURSOR ↵] to enter the character.  
Repeat steps ①~② to complete the keyword.

### Editing keywords

#### To move the cursor

Press [◀◀ CURSOR] or [CURSOR ▶▶].

Remote control: Press [CURSOR (↵ or ↵)].

#### Deleting a character

- Move the cursor over the character to be deleted.
- Press [DELETE] (remote control: Press [DEL]).

#### Editing a character

- Move the cursor over the character to be edited.
- Enter the correct character.

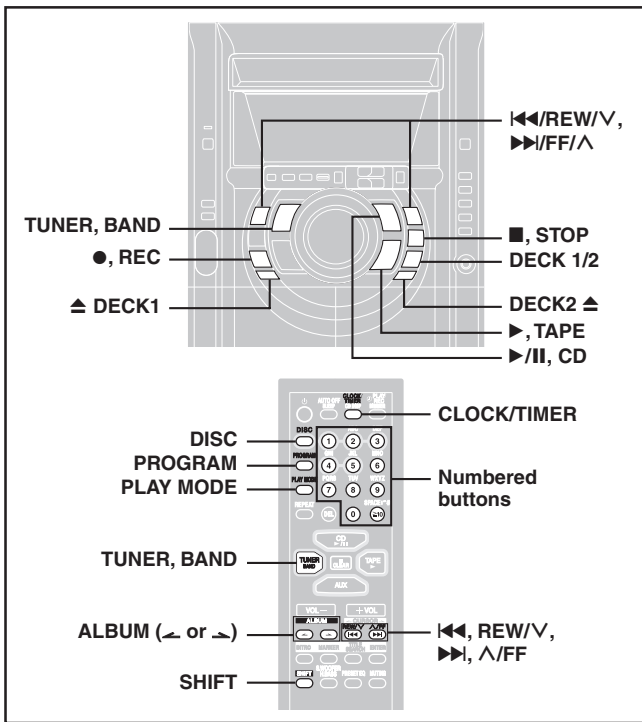

## Radio

### Manual tuning

- 1 Press [TUNER, BAND] to select band.  
The unit comes on.  
Every time you press the button:  
FM ↔ AM
- 2 Press [PLAY MODE] on the remote control to select "MANUAL".  
Every time you press the button:  
MANUAL ↔ PRESET
- 3 Hold down [◀◀/REW/V] or [▶▶/FF/Λ] for a moment to search for a station.  
The frequency stops when it finds a clear station.  
To stop during the process, press [◀◀/REW/V] or [▶▶/FF/Λ].  
Under excessive interference, a station may not be found.  
Press [◀◀/REW/V] or [▶▶/FF/Λ] repeatedly to tune step-by-step.  
"TUNED" is displayed when a radio station is tuned.  
"ST" is displayed when a stereo FM broadcast is being received.

#### If noise is excessive in FM

##### Remote control only

Hold down [PLAY MODE] to display "MONO".

Monaural sound is selected and noise reduces when reception is weak.

Hold down [PLAY MODE] again to cancel the mode.

"MONO" is also cancelled if the frequency is changed.

#### To receive FM broadcasts allocated in 0.1 MHz steps

##### Main unit only

Hold down [TUNER, BAND]. The display changes in a few seconds to show the current minimum FM frequency. Continue to hold down the button until the minimum frequency changes. The step is changed. Repeat the above to change the step back.

#### Note

- After changing the "allocation" setting, the frequencies you previously preset in the memory will be cleared.
- Sound is momentarily interrupted if you load/unload tapes while listening to an AM broadcast.

### Preset tuning

#### Remote control only

There are two methods of pre-setting stations.

**Automatic presetting** : All the stations the tuner can receive are preset.

**Manual presetting** : You can select the stations to preset and the order they are preset in.

Up to 15 stations each can be set in the FM and AM bands.

#### Preparation:

Press [TUNER, BAND] to select "FM" or "AM".

## Radio

### Automatic presetting

Do the following once each for FM and AM.

**Preparation:** Tune to the frequency where pre-setting is to begin.

**Hold down [PROGRAM] until the frequency changes.**

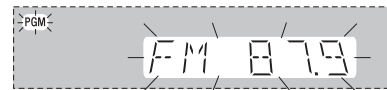

The tuner presets all the stations it can receive into the channels in ascending order. When finished, the last station memorized is tuned in.

### Manual presetting

Pre-set the stations one at a time.

- ① Press [PROGRAM] then press [◀◀, REW/V] or [▶▶, Λ/FF] to tune to the desired station.
- ② Press [PROGRAM] then press [◀◀, REW/V] or [▶▶, Λ/FF] to select a channel.
- ③ Press [PROGRAM].

The station occupying a channel is erased if another station is preset in that channel.

### Selecting channels

**Press the numbered buttons to select the channel.**

To enter a 2-digit channel, press [≥10], then the two digits.

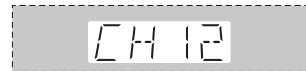

- OR
- ① Press [PLAY MODE] to select "PRESET".
  - ② Press [◀◀, REW/V] or [▶▶, Λ/FF] to select the channel.

### Optional antenna connections

Use outdoor antenna if radio reception is poor.

#### FM outdoor antenna

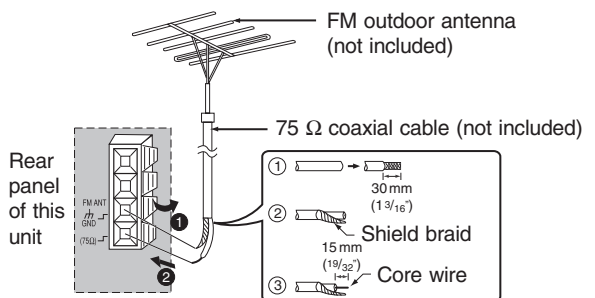

- Disconnect the FM indoor antenna.
- The antenna should be installed by a competent technician.

#### AM outdoor antenna

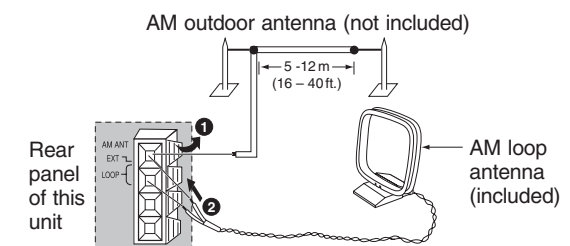

Run a piece of vinyl wire horizontally across a window or other convenient location.

Leave the loop antenna connected.

#### Note

Disconnect the outdoor antenna when the unit is not in use.

Do not use the outdoor antenna during an electrical storm.

# Cassettes

## Playback

You can use either deck 1 or deck 2 for tape playback.

Use normal position tapes.

High position and metal position tapes can be played, but the unit will not be able to do full justice to the characteristics of these tapes.

### 1 Press [▶, TAPE].

The unit comes on.

If a cassette was loaded, play starts automatically (One touch play).

### 2 Press [▲ DECK1] or [DECK2 ▲] and insert the cassette.

Insert with the side to be played facing towards you and the exposed tape facing down.

Close the holder by hand.



### 3 Press [▶, TAPE] to start playback.

To play on the other side of the tape, turn the tape over and press [▶, TAPE].

### To stop tape playback

Press [■, STOP].

### To fast-forward or rewind

Press [◀◀/REW/V] (rewind) or [▶▶/FF/∧] (fast-forward).

### To select between loaded decks

Press [DECK 1/2] (remote control: [PLAY MODE]).

#### Note

- Tape playback is momentarily interrupted if you open the other deck.
- Tapes exceeding 100 minutes are thin and can break or get caught in the mechanism.
- Tape slack can get caught up in the mechanism and should be taken up before the tape is played.
- Endless tapes can get caught up in the deck's moving parts if used incorrectly.

## Recording

### Selection of tapes for recording

Use normal position tapes.

High position and metal position tapes can be used, but this unit will not be able to record or erase them correctly.

### Preparation:

Wind up the leader tape so recording can begin immediately.

### 1 Press [DECK2 ▲] and insert the cassette to be recorded.

Insert with the side to be recorded facing towards you and the exposed tape facing down.

### 2 Select the source to be recorded.

#### Radio recording:

Tune in the station. (⇒ page 10)

#### Disc recording:

- ① Insert the disc(s) you want to record.  
Press [▶/II, CD] and then [■, STOP].
- ② Prepare the desired disc recording mode.

#### Remote control only

- To record programmed tracks  
On page 8, "Program play", do steps:

**CD** 1 ~ 3

**MP3** 1 ~ 4

- To record specific discs/tracks
  1. Press [PLAY MODE] to select the desired mode.  
(⇒ page 7)
  2. Press [DISC] and then [1]–[5] to select the disc.  
Ensure disc is stopped.
  3. **MP3** For 1-ALBUM mode and 1-SONG mode: Press [ALBUM (◀ or ▶)] to select the album.
  4. For 1-SONG mode: Press [◀◀, REW/V] or [▶▶, ∧/FF] to select the track.

#### Tape-to-tape recording:

- ① Press [▶, TAPE] and then [■, STOP].
- ② Press [▲ DECK1] and insert the cassette you want to record.

### 3 Press [●, REC] to start recording.

### To stop recording

Press [■, STOP].

### If the tape finishes before the disc

The disc continues playing. Press [■, STOP] to stop it.

### To record on the other side of the tape

Turn the tape over and press [●, REC].

#### Note

- Changes to volume and sound/field quality do not affect recording.
- You cannot open deck 1 while recording.
- You cannot fast-forward or rewind one deck while recording with the other.
- When recording an AM broadcast, sound is momentarily interrupted when you start and stop the recording.

### Erase prevention

Use a screwdriver or similar object to break out the tab.

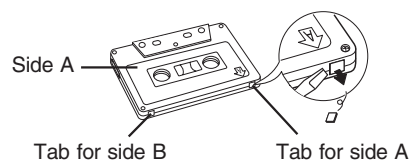

### To re-record on a protected cassette

Cover the hole with adhesive tape.



### To erase a tape

1. Press [▶, TAPE] and then [■, STOP].
2. Insert the recorded tape into deck 2.  
Ensure there is no tape in deck 1.
3. Press [●, REC].

## Setting the time

### Remote control only

This is a 12-hour clock.

### 1 Switch on the power.

### 2 Press [SHIFT] + [CLOCK/TIMER] to select "CLOCK".

Every time you press the button:

CLOCK → ⊙PLAY → ⊙REC

↑ Previous display ↓

### 3 (Within 7 seconds or so)

Press [◀◀, REW/V] or [▶▶, ∧/FF] to set the time.

### 4 Press [SHIFT] + [CLOCK/TIMER] to finish setting the time.

The display will return to whatever was displayed before you set the time.

### To display the time

Press [SHIFT] + [CLOCK/TIMER] once when the unit is on or at standby mode.

The time is shown for about 5 seconds.

#### Note

Reset the clock regularly to maintain accuracy.

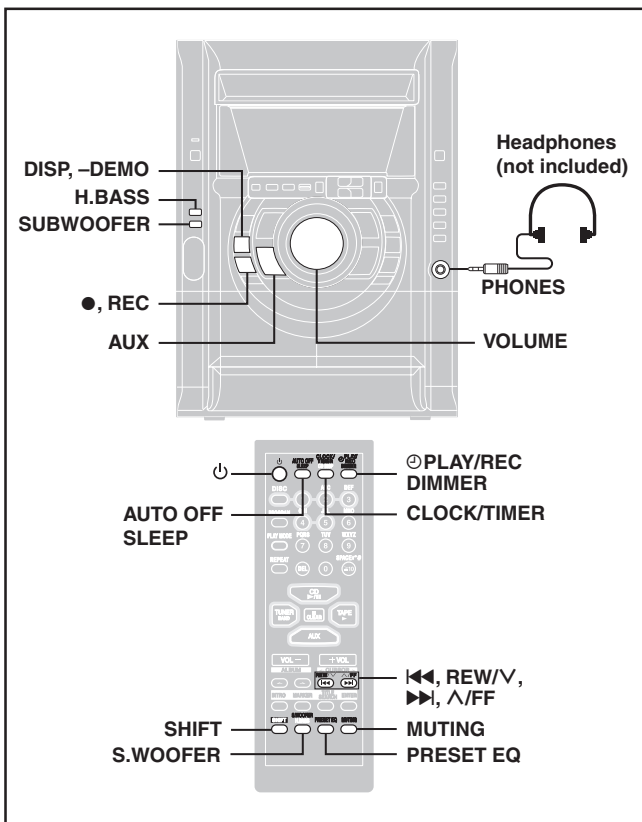

## Timers

### 4 Press [⏻] to turn the unit off.

The unit must be off for the timers to operate.

- **Play timer:** Play will start in the set condition at the set time with volume increasing gradually to the set level.
- **Record timer:** The unit comes on 30 seconds before the set time with the volume muted.

#### To cancel the timer

Press [SHIFT] + [⏻PLAY/REC] to clear the timer indicator from the display.

(The timer comes on at the set time everyday if the timer is on.)

#### To change the settings (when the unit is on)

##### To change the play/record times

Do steps 1, 2 and 4.

##### To change the source or volume

1. Press [SHIFT] + [⏻PLAY/REC] to clear the timer indicator from the display.

2. Make changes to the source or volume.

3. Do steps 3 to 4.

#### To check the settings

Press [SHIFT] + [CLOCK/TIMER] while the unit is on to select "⏻PLAY" or "⏻REC".

The settings are shown in the following order:

Play timer: on time → off time → source → volume

Record timer: on time → off time → source

To check the settings while the unit is off, press [SHIFT] + [CLOCK/TIMER] twice.

#### If you use the unit after the timers are set

After using, check that the correct tape/disc are loaded before turning the unit off.

#### Note

- If you turn the unit off and on again while a timer is functioning, the OFF time setting will not be activated.
- If you selected AUX as the source, when the timer comes on, the unit turns on and engages "AUX" as the source. If you want to playback or record from a connected unit, set that unit's timer to the same time. (See the connected unit's instruction manual.)

## Timers

### Using the play/record timer

#### Remote control only

You can set the timer to come on at a certain time to wake you up (play timer) or to record a radio station or from the aux source (record timer).

The play and record timers cannot be used together.

#### Preparations:

- Turn the unit on and set the clock (⇒ page 11).
- **For the play timer**, prepare the desired music source (tape/disc/radio/aux), and set the volume.
- **For the record timer**, check the cassette's erasure prevention tabs (⇒ page 11) and insert the tape in deck 2 (⇒ page 11). Tune to the radio station (⇒ page 10) or select the aux source (⇒ page 13).

### 1 Press [SHIFT] + [CLOCK/TIMER] to select the timer function.

Every time you press the button:

CLOCK → ⏻PLAY → ⏻REC

↑ Previous display ↓

⏻PLAY: to set the play timer

⏻REC: to set the record timer

(Proceed to the next step within 8 seconds)

### 2 ON time setting

① Press [⏮, REW/V] or [⏭, ^/FF] to set the time.

② Press [SHIFT] + [CLOCK/TIMER].

#### OFF time setting

Repeat steps ① and ②.

### 3 Press [SHIFT] + [⏻PLAY/REC] to display the timer indicator.

Every time you press the button:

⏻PLAY → ⏻REC

↑ (off) ↓

⏻PLAY: to turn the play timer on

⏻REC: to turn the record timer on

(The indicator doesn't appear if the ON and OFF times or the clock hasn't been set.)

### Using the sleep timer

#### Remote control only

This timer turns the unit off after a set time.

#### While enjoying the desired source:

Press [SLEEP] to select the time (minutes).

Every time you press the button:

→ SLEEP 30 → SLEEP 60 → SLEEP 90 → SLEEP 120 → SLEEP OFF →

#### To cancel the sleep timer

Press [SLEEP] to select "SLEEP OFF".

#### To confirm the remaining time

Press [SLEEP] once.

The remaining time is shown for about 5 seconds.

#### To change the setting

Press [SLEEP] to select the new setting.

You can use the sleep timer in combination with the play/record timer. Make sure the unit is off before the play/record timer's start time.

#### Note

The sleep timer will be turned off when you start recording.

# Sound quality/sound field

## Using the built-in sound quality/sound field settings

### Remote control only

Press [PRESET EQ] to select a setting.

Every time you press the button:

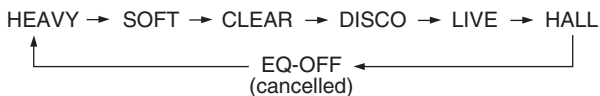

- HEAVY (sound quality)** : Adds punch to rock
- SOFT (sound quality)** : For background music
- CLEAR (sound quality)** : Clarifies higher sounds
- DISCO (sound field)** : Produces sound with the same kind of lengthy reverberations heard at a disco
- LIVE (sound field)** : Makes vocals more alive
- HALL (sound field)** : Adds an expansiveness to the sound to produce the atmosphere of a great concert hall

### Note

You cannot use PRESET EQ together with H.BASS.

## Enhancing the bass sound

You can enhance low-frequency sound so that heavy bass sound can be heard clearly, even if the acoustics of your room are not optimal.

Press [H.BASS].

The button light comes on.

Press the button again to cancel.

The button light goes out.

## Boosting the subwoofer

Press [SUBWOOFER].

Remote control: Press [SHIFT] + [S.WOOFER].

The button light comes on.

Each time you press the button:

MID (medium) → MAX (high) → Light off (off)



**To cancel**

Press [SUBWOOFER] to turn the light off.

Remote control: Press [SHIFT] + [S.WOOFER].

### Note

You cannot use this function when headphones are connected.

## Other functions

### External unit connections

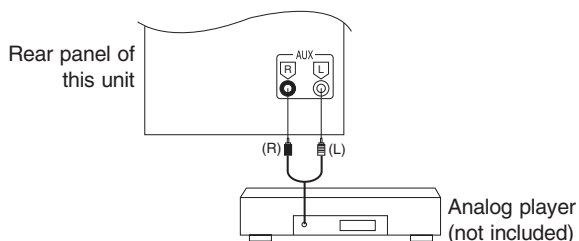

- An analog player with a built-in phono equalizer can be connected.
- For details, refer to the instruction manual of the units which are to be connected.
- When units other than those described above are to be connected, please consult your audio dealer.

### Using an external unit

(See above for external unit connection.)

1. Press [AUX].  
The unit comes on.
2. **For listening:** Proceed to step 3.  
**For recording:** Press [●, REC] (recording starts).
3. Start playback from the external source. (For details, refer to the external unit's instruction manual.)

### Using headphones (not included)

Reduce the volume level and connect the headphones.

Plug type: 3.5 mm (1/8") stereo

### Note

Avoid listening for prolonged periods of time to prevent hearing damage.

### Auto-off function

**Remote control only**

When disc or tape is selected as the source

To save power, the unit turns off if it is left unused for ten minutes.

This function does not work if the source is tuner or AUX.

Press [SHIFT] + [AUTO OFF].

"AUTO OFF" is shown on the display.

The setting is maintained even if the unit is turned off.

If you select tuner or AUX as the source, "AUTO OFF" goes out. It comes on again when you select disc or tape.

**To cancel**

Press [SHIFT] + [AUTO OFF] again.

### Convenient functions

#### To dim the display panel

**Remote control only**

Press [DIMMER].

The display is dimmed and the indicators are turned off.

(The AC supply indicator remains on.)

Press [DIMMER] again to restore the display.

#### Switching displays

Press [DISP, -DEMO] to select the desired display mode.

Every time you press the button:

Normal → Peak hold → Reflection

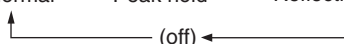

#### To mute the volume

**Remote control only**

Press [MUTING].

Press the button again to cancel.

"MUTING" goes out.

To cancel from the unit, turn [VOLUME] to minimum (-dB), then raise it to the required level.

Muting is also cancelled when the unit is turned off.

# Troubleshooting guide

Before requesting service, make the following checks. If you are in doubt about some of the check points, or if the remedies indicated in the chart do not solve the problem, refer to the "Customer Services Directory" on the back cover if you reside in the U.S.A., or refer to the "Product information" on page 15 if you reside in Canada.

Reference pages are shown as black circled numbers ❹.

## Common Problems

Although the unit is in standby mode, the display lights up and changes continuously.	Turn off the demo function. ❹ If you set the clock, demo function will be turned off automatically. ❶
No sound. Sound stops.	Turn the volume up. Switch off the unit, determine and correct the cause, then switch the unit on. Causes include shorting of the positive and negative speaker wires, straining of the speakers through excessive volume or power, and using the unit in a hot environment.
Sound is unfixed, reversed or comes from one speaker only.	Check the speaker connections. ❹
Humming heard during play.	An AC power supply cord or fluorescent light is near the cables. Keep other appliances and cords away from this unit's cables.
"ERROR" is displayed.	Incorrect operation performed. Read the instructions and try again.
"- -: -" appears on the display at standby mode.	You plugged the AC power supply cord in for the first time or there was a power failure recently. Set the time. ❶
"F61" is displayed.	Check and correct the speaker cords connection. ❹ If this does not fix the problem, there is a power supply problem. Consult the dealer.

## Listening to the radio

Noise is heard. The stereo indicator flickers or doesn't light. Sound is distorted.	Use an outdoor antenna. ❶
A beat sound is heard.	Turn the TV off or separate it from the unit.
A low hum is heard during AM broadcasts.	Separate the antenna from other cables and cords.

## When there is a television set nearby

The picture on the TV disappears or stripes appear on the screen.	The location and orientation of the antenna are incorrect. If you are using an indoor antenna, change to an outdoor antenna. The TV antenna wire is too close to the unit. Separate the antenna wire of the TV set from the unit.
-------------------------------------------------------------------	--------------------------------------------------------------------------------------------------------------------------------------------------------------------------------------------------------------------------------------

## Using the cassette deck

Poor quality sound.	Clean the heads. ❶
Recording is not possible.	If the erasure prevention tabs have been removed, cover the holes with adhesive tape. ❶

## Playing discs

The display is wrong or play won't start.	The disc may be upside down. ❸ Wipe the disc. Replace the disc if it is scratched, warped, or non-standard. Condensation may have formed inside the unit due to a sudden change in temperature. Wait for about an hour for it to clear and try again.
Cannot perform all-disc random play.	All-disc random mode cannot be used for MP3 discs. Change the disc or select another play mode. ❷
The total number of tracks displayed differs each time the same disc is inserted. Unusual sound is heard.	The disc may be scratched, or its data may be defective. Replace the disc.
CD-RW cannot be read.	The disc was incompletely formatted. Use the recording equipment to fully format the disc before recording.
"VBR-" is displayed instead of the remaining play time.	The unit cannot display the remaining play time for variable bit rate (VBR) tracks.
"TAKE OUT/DISC" appears on the display.	There is a problem with the disc mechanism. (A power failure may have occurred.) The tray will open automatically. Remove the disc from the tray, and after ensuring there is no disc in the tray, close it. The unit will make the disc changing noises for a few moments and then it should operate normally.

## Remote control

Remote control doesn't work.	Check that the batteries are inserted correctly. ❸ Replace the batteries if they are worn.
------------------------------	-----------------------------------------------------------------------------------------------

### Memory reset (Initialization)

When the following situations occur, refer to the instructions below to reset the memory:

- There is no response when buttons are pressed.
- You want to clear and reset the memory contents.

#### To reset memory

- 1 Disconnect the AC power supply cord. (Wait at least 3 minutes before proceeding to step 2.)
- 2 While pressing and holding down [⏻, POWER] on the main unit, reconnect the AC power supply cord.  
"-----" appears on the display.
- 3 Release [⏻, POWER].  
All the settings are returned to the factory preset.  
You will need to reset the memory items.

# Specifications

## AMPLIFIER SECTION

### RMS output power

#### THD 10%, both channels driven

##### 1 kHz

(Low channel) 75 W per channel (5 Ω)

##### 10 kHz

(High channel) 70 W per channel (5 Ω)

##### 80 Hz

(Subwoofer channel) 160 W (8 Ω)

**Total power output** 450 W

### FTC output power

#### THD 10%, both channels driven

##### 100 Hz–3 kHz

(Low channel) 59 W per channel (5 Ω)

##### 3 kHz–10 kHz

(High channel) 57 W per channel (5 Ω)

##### 50 Hz–100 Hz

(Subwoofer channel) 130 W (8 Ω)

**Total FTC power** 362 W

## FM/AM TUNER, TERMINALS SECTION

### Preset station

FM 15 stations

AM 15 stations

### Frequency Modulation (FM)

#### Frequency range

87.9–107.9 MHz (200 kHz steps)

87.5–108.0 MHz (100 kHz steps)

#### Sensitivity

2.5 μV (IHF)

#### S/N 26 dB

2.2 μV

#### Antenna terminal(s)

75 Ω (unbalanced)

### Amplitude Modulation (AM)

#### Frequency range

520–1710 kHz (10 kHz steps)

#### Sensitivity

S/N 20 dB (at 1000 kHz) 560 μV/m

### Audio performance (Amplifier)

#### Input sensitivity/Input impedance

Aux 250 mV, 14.7 kΩ

### Phone jack

Terminal Stereo, 3.5 mm (1/8") jack

## CASSETTE DECK SECTION

### Track system

4 track, 2 channel

### Heads

**Record/playback** Solid permalloy head

**Erasure** Double gap ferrite head

### Motor

DC servo motor

### Recording system

AC bias 100 kHz

### Erasing system

AC erase 100 kHz

### Tape speed

4.8 cm/s (1 7/8 ips)

### Overall frequency response

#### (+3 dB, –6 dB at DECK OUT)

**NORMAL** 35 Hz–14 kHz

### S/N ratio

50 dB (A weighted)

### Wow and flutter

0.18% (WRMS)

### Fast forward and rewind time

Approx. 120 seconds with

C-60 cassette tape

## DISC SECTION

### Discs played [8 cm (3") or 12 cm (5")]

(1) CD-Audio (CD-DA)

(2) CD-R/RW (CD-DA, MP3 formatted

disc)

(3) MP3

### Bit rate

**MP3** 32 kbps–320 kbps

### Sampling frequency

**MP3** 32 kHz, 44.1 kHz, 48 kHz

### CD

44.1 kHz

### Decoding

16 bit linear

### Digital filter

8 fs

### D/A converter

MASH (1 bit DAC)

### Pickup

#### Wavelength

780 nm

#### Beam Source

Semiconductor laser

### Audio output (Disc)

#### Number of channels

2 (Stereo) (FL, FR)

## SPEAKER SECTION

### Front speakers SB-AK630

#### Type

3 way, 3 speaker system (Bass reflex)

#### Impedance

**HIGH** 5 Ω

**LOW** 5 Ω

#### Speaker(s)

**Woofers** 16 cm (6 1/2") cone type

**Tweeter** 6 cm (2 3/8") cone type

**Super tweeter** Piezo type

#### Input power (IEC)

**HIGH** 70 W (Max)

**LOW** 75 W (Max)

#### Output sound pressure level

83 dB/W (1.0 m)

#### Cross over frequency

2.6 kHz, 10 kHz

**Frequency range** 37 Hz–23 kHz (–16 dB)

44 Hz–22 kHz (–10 dB)

**Dimensions (WxHxD)** 240 x 330 x 230 mm

(9 7/16" x 13" x 9 1/16")

#### Mass

3.2 kg (7.1 lb.)

### Subwoofer SB-WAK630

#### Type

1 way, 1 speaker system (Bass reflex)

#### Impedance

8 Ω

#### Speaker(s)

**Subwoofer** 16 cm (6 1/2") cone type

**Input power (IEC)** 160 W (Max)

#### Output sound pressure level

80 dB/W (1.0 m)

**Frequency range** 40 Hz–220 Hz (–16 dB)

45 Hz–180 Hz (–10 dB)

**Dimensions (WxHxD)** 240 x 330 x 267 mm

(9 7/16" x 13" x 10 1/2")

#### Mass

3.4 kg (7.5 lb.)

## GENERAL

### Power supply

AC 120 V, 60 Hz

### Power consumption

255 W

**Dimensions (WxHxD)** 250 x 330 x 341 mm

(9 7/32" x 13" x 13 7/16")

#### Mass

7.1 kg (15.7 lb.)

### Operating temperature range

+5 to +35 °C (+41 to +95 °F)

### Operating humidity range

5 to 90% RH (no condensation)

Power consumption in standby mode: 0.38 W

### Note:

1. Specifications are subject to change without notice.

Mass and dimensions are approximate.

2. Total harmonic distortion is measured by the digital spectrum analyzer.

3. The labels "HIGH" and "LOW" on the rear of the speakers refer to High frequency and Low frequency.

## Maintenance

### If the surfaces are dirty

To clean this unit, wipe with a soft, dry cloth.

- Never use alcohol, paint thinner or benzine to clean this unit.
- Before using a chemically treated cloth, read the instructions that came with the cloth carefully.

### For a cleaner, crisper sound

Clean the heads regularly to assure good quality playback and recording.

Use a cleaning tape (not included).

## Product Service

1. **Damage requiring service**—The unit should be serviced by qualified service personnel if:

- (a) The AC power supply cord or AC adaptor has been damaged; or
- (b) Objects or liquids have gotten into the unit; or
- (c) The unit has been exposed to rain; or
- (d) The unit does not operate normally or exhibits a marked change in performance; or
- (e) The unit has been dropped or the cabinet damaged.

2. **Servicing**—Do not attempt to service the unit beyond that described in these operating instructions. Refer all other servicing to authorized servicing personnel.

3. **Replacement parts**—When parts need replacing ensure the servicer uses parts specified by the manufacturer or parts that have the same characteristics as the original parts. Unauthorized substitutes may result in fire, electric shock, or other hazards.

4. **Safety check**—After repairs or service, ask the servicer to perform safety checks to confirm that the unit is in proper working condition.

### Product information

For product information or assistance with product operation:

**In the U.S.A., refer to "Customer Services Directory" on the back cover.**

**In Canada, contact the Panasonic Canada Inc. Customer Care Centre at 905-624-5505, or visit the website ([www.panasonic.ca](http://www.panasonic.ca)), or an authorized Servicentre closest to you.**

# Limited Warranty (ONLY FOR U.S.A.)

Panasonic Consumer Electronics Company,  
Division of Panasonic Corporation of North America  
One Panasonic Way Secaucus, New Jersey 07094

Panasonic Puerto Rico, Inc.  
Ave. 65 de Infantería, Km. 9.5  
San Gabriel Industrial Park, Carolina, Puerto Rico 00985

## Panasonic Audio Products Limited Warranty

### Limited Warranty Coverage

If your product does not work properly because of a defect in materials or workmanship, Panasonic Consumer Electronics Company or Panasonic Puerto Rico, Inc. (collectively referred to as "the warrantor") will, for the length of the period indicated on the chart below, which starts with the date of original purchase ("warranty period"), at its option either (a) repair your product with new or refurbished parts, or (b) replace it with a new or a refurbished product. The decision to repair or replace will be made by the warrantor.

Product or Part Name	Parts	Labor
Audio Products (except items listed below)	One (1) year	One (1) year
USB Reader-Writer, Personal Computer Card Adapters (in exchange for defective item)	One (1) year	Not Applicable
Accessories: Headphones, Cartridges, Microphones, Adapters	Ninety (90) days	Ninety (90) days
Rechargeable Batteries, DVD-R/-RAM Discs (in exchange for defective item)	Ten (10) days	Not Applicable
SD Memory Cards, Rechargeable Battery Packs (in exchange for defective item)	Ninety (90) days	Not Applicable

During the "Labor" warranty period there will be no charge for labor. During the "Parts" warranty period, there will be no charge for parts. You must carry-in or mail-in your product during the warranty period. If non-rechargeable batteries are included, they are not warranted. This warranty only applies to products purchased and serviced in the United States or Puerto Rico. This warranty is extended only to the original purchaser of a new product which was not sold "as is". A purchase receipt or other proof of the original purchase date is required for warranty service.

### Carry-In or Mail-In Service

For Carry-In or Mail-In Service in the United States call 1-800-211-PANA (1-800-211-7262) or visit Panasonic web site: <http://www.panasonic.com>  
For assistance in Puerto Rico call Panasonic Puerto Rico, Inc. (787)-750-4300 or fax (787)-768-2910.

### Limited Warranty Limits And Exclusions

This warranty ONLY COVERS failures due to defects in materials or workmanship, and DOES NOT COVER normal wear and tear or cosmetic damage. The warranty ALSO DOES NOT COVER damages which occurred in shipment, or failures which are caused by products not supplied by the warrantor, or failures which result from accidents, misuse, abuse, neglect, mishandling, misapplication, alteration, faulty installation, set-up adjustments, misadjustment of consumer controls, improper maintenance, power line surge, lightning damage, modification, or commercial use (such as in a hotel, office, restaurant, or other business), rental use of the product, service by anyone other than a Factory Servicenter or other Authorized Servicer, or damage that is attributable to acts of God.

**THERE ARE NO EXPRESS WARRANTIES EXCEPT AS LISTED UNDER "LIMITED WARRANTY COVERAGE". THE WARRANTOR IS NOT LIABLE FOR INCIDENTAL OR CONSEQUENTIAL DAMAGES RESULTING FROM THE USE OF THIS PRODUCT, OR ARISING OUT OF ANY BREACH OF THIS WARRANTY.** (As examples, this excludes damages for lost time, travel to and from the servicer, loss of media or images, data or other memory content. The items listed are not exclusive, but are for illustration only.) **ALL EXPRESS AND IMPLIED WARRANTIES, INCLUDING THE WARRANTY OF MERCHANTABILITY, ARE LIMITED TO THE PERIOD OF THE LIMITED WARRANTY.**

Some states do not allow the exclusion or limitation of incidental or consequential damages, or limitations on how long an implied warranty lasts, so the exclusions may not apply to you. This warranty gives you specific legal rights and you may also have other rights which vary from state to state. If a problem with this product develops during or after the warranty period, you may contact your dealer or Servicenter. If the problem is not handled to your satisfaction, then write to the warrantor's Consumer Affairs Department at the addresses listed for the warrantor.

**PARTS AND SERVICE WHICH ARE NOT COVERED BY THIS LIMITED WARRANTY ARE YOUR RESPONSIBILITY.**

## Customer Services Directory

Obtain Product Information and Operating Assistance; locate your nearest Dealer or Servicenter; purchase Parts and Accessories; or make Customer Service and Literature requests by visiting our Web Site at:

<http://www.panasonic.com/consumersupport>

or, contact us via the web at:

<http://www.panasonic.com/contactinfo>

You may also contact us directly at:

1-800-211-PANA (7262),

Monday-Friday 9 am-9 pm; Saturday-Sunday 10 am-7 pm, EST.

For hearing or speech impaired TTY users, TTY: 1-877-833-8855

## Accessory Purchases

Purchase Parts, Accessories and Instruction Books online for all Panasonic Products by visiting our Web Site at:

<http://www.pasc.panasonic.com>

or, send your request by E-mail to:

[npcparts@us.panasonic.com](mailto:npcparts@us.panasonic.com)

You may also contact us directly at:

1-800-332-5368 (Phone) 1-800-237-9080 (Fax Only) (Monday - Friday 9 am to 8 pm, EST.)

Panasonic Services Company

20421 84th Avenue South, Kent, WA 98032

(We Accept Visa, MasterCard, Discover Card, American Express, and Personal Checks)

For hearing or speech impaired TTY users, TTY: 1-866-605-1277

## Service in Puerto Rico

Panasonic Puerto Rico, Inc.

Ave. 65 de Infantería, Km. 9.5, San Gabriel Industrial Park, Carolina, Puerto Rico 00985

Phone (787)750-4300, Fax (787)768-2910

Panasonic Consumer Electronics  
Company, Division of Panasonic  
Corporation of North America

One Panasonic Way Secaucus,  
New Jersey 07094

<http://www.panasonic.com>

Panasonic Puerto Rico, Inc.

Ave. 65 de Infantería, Km. 9.5

San Gabriel Industrial Park, Carolina,

Puerto Rico 00985

Panasonic Canada Inc.

5770 Ambler Drive  
Mississauga, Ontario  
L4W 2T3

[www.panasonic.ca](http://www.panasonic.ca)

